

SIGMA WALL WASHER 2

3 W, 6 W, 12 W



PRODUCT DESCRIPTION

Sigma Wall Washer 2 is placed along walls to obtain a texturing effect. It can be used outside to showcase façades and buildings. Its light flow can be adjusted precisely.

Reduction of maintenance tasks can be of a particular importance.

- ⌋ **Ideal for personalized accentuated lighting of buildings**
- ⌋ **Resistant to shocks and vibrations**
- ⌋ **No blinding or ultraviolet**
- ⌋ **PWM technology for optimal rendering with no heat emission**
- ⌋ **Adjustable viewing angle to light up a specific zone**

DIMENSIONAL DRAWING

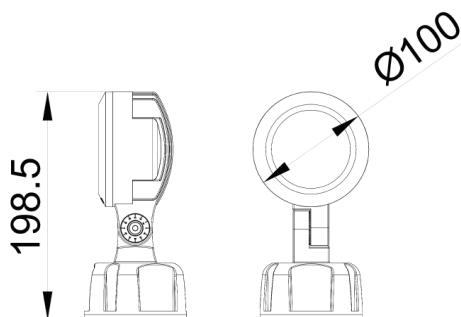

APPLICATIONS

- > FAÇADE LIGHTING
- > PUBLIC LIGHTING
- > ADVERTISING
- > OUTDOOR LIGHTING
- > GYMNASIUMS
- > WAREHOUSES

FEATURES

Reference	Designation	Power (Watt)	Color temperature (Kelvin)	Ingress Protection	Voltage	CRI	Viewing angle	Lumens
WALL 003 443 03	Sigma Round Wall Washer 3W	3 W	5 000K	IP 65	100 - 240 V	65	60°	180
WALL 006 444 04	Sigma Round Wall Washer 6W	6 W	RGB	IP 65	100 - 240 V	-	60°	-
WALL 006 445 03	Sigma Round Wall Washer 6W	6 W	5 000K	IP 65	100 - 240 V	65	30°	360
WALL 012 446 04	Sigma Round Wall Washer 12W	12 W	RGB	IP 65	100 - 240 V	-	60°	-
WALL 012 448 03	Sigma Round Wall Washer 12W	12 W	5 000K	IP 65	100 - 240 V	65	30°	720

SIGMA ROUND WALL WASHER 2 3W, 6W, 12W

PHOTOMETRIC INFORMATIONS 3W

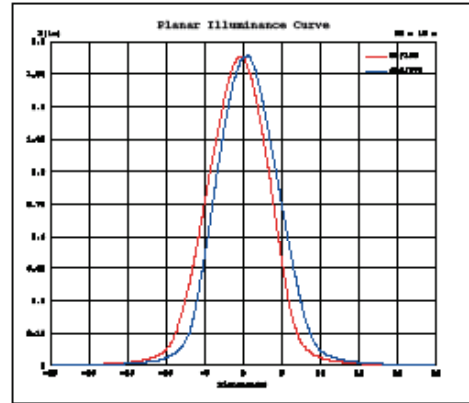
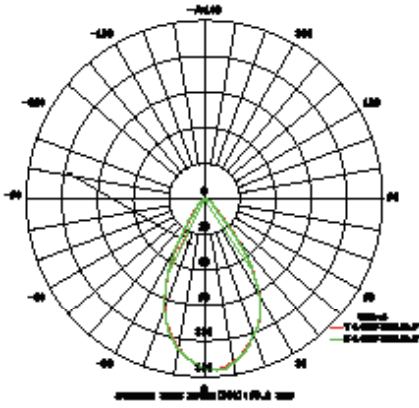

PHOTOMETRIC INFORMATIONS 6W RGB

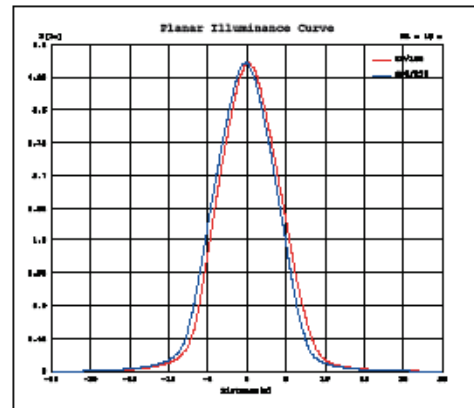
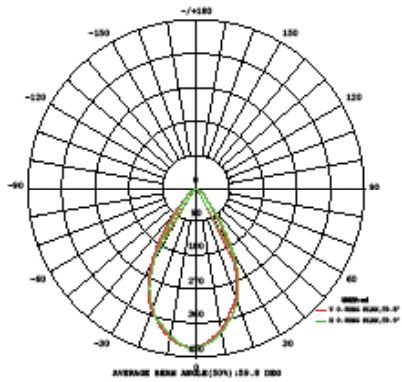

PHOTOMETRIC INFORMATIONS 6W 5 000K

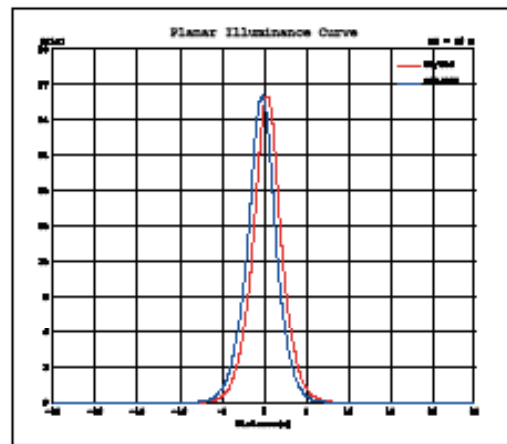
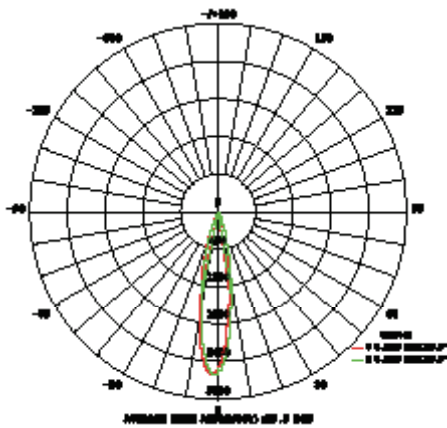

PHOTOMETRIC INFORMATIONS 12W RGB

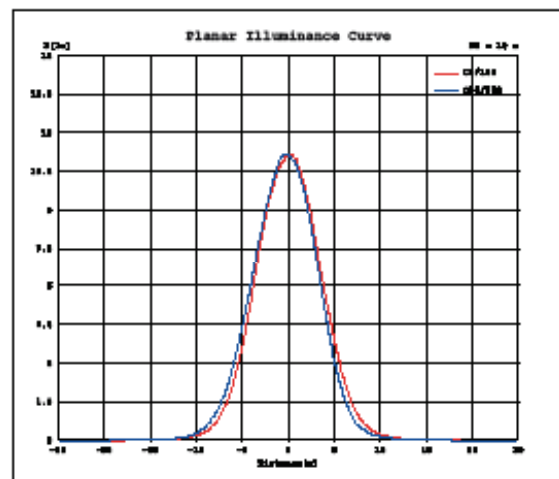
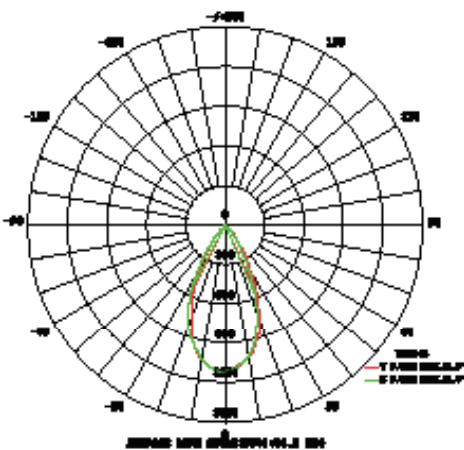

SIGMA ROUND WALL WASHER 2 3W, 6W, 12W

PHOTOMETRIC INFORMATIONS 12W 5 000K

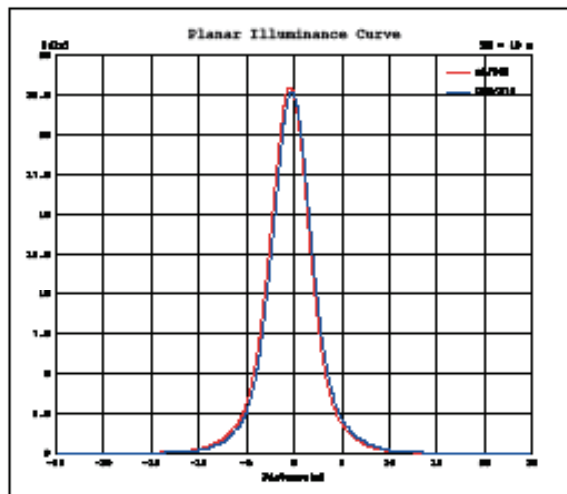
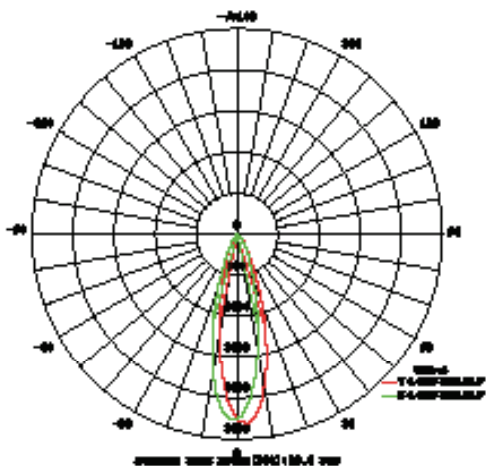

CONE OF LIGHT 3W 5 000K

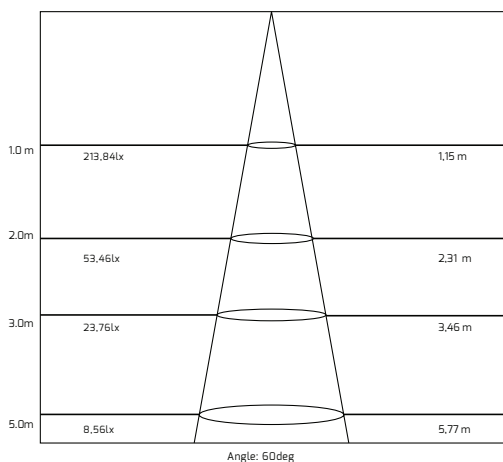

CONE OF LIGHT 6W RGB

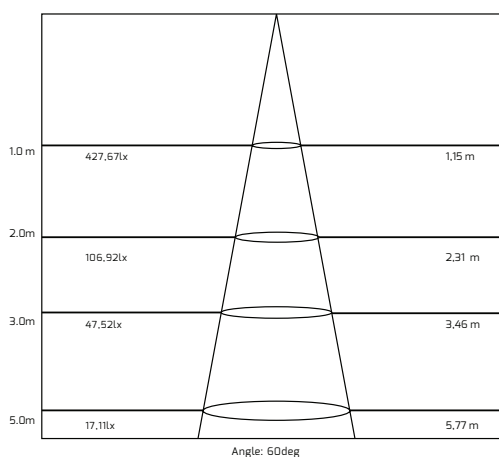

CONE OF LIGHT 6W 5 000K

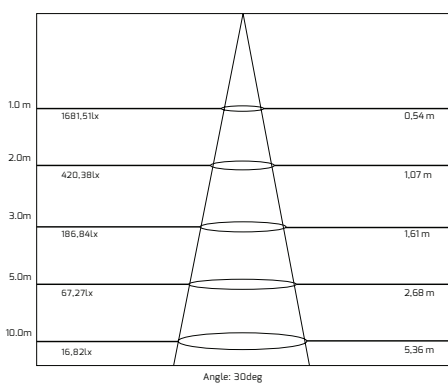

CONE OF LIGHT 12W 5 000K

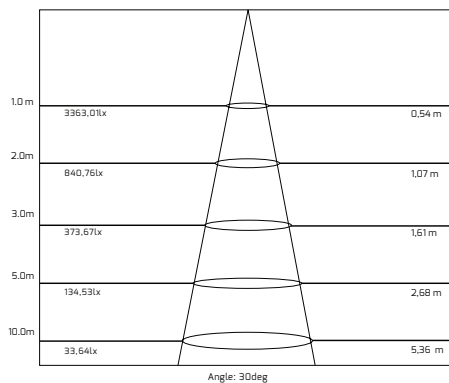

CONE OF LIGHT 12W RGB

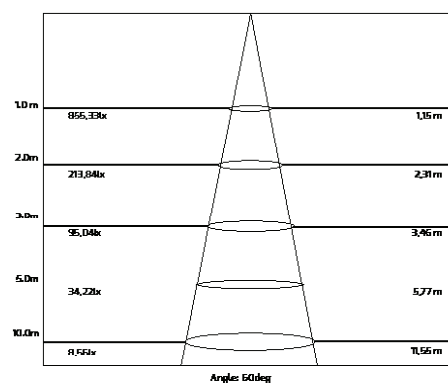

ENVIRONMENT



PRODUCT

